



SHEN ZHEN ZLONE LIGHTING CO., LTD

Office : 317, Building 1, Cloud Park, No 233 Bulong Road, Buji Street,
Longgan District, Shenzhen, China
Factory One : 7/F, Block A-B, HongLianYing Science & Technology Park,
SiLi Road, Guan Lan, Longhua New District, Shenzhen, China
Factory Two : 5/F, Rossonix factory, No.6 Tianqin Street, Henglang Town,
Zhongshan City, China
Tel : 0086-755-29406151
Fax : 0086-755-82814006
Email : sales@zlonelighting.com
Website : www.zlonelighting.com

A nighttime photograph of a city skyline, likely Shenzhen, with numerous illuminated skyscrapers and buildings. The image is partially obscured by a large green curved shape at the bottom.

SHEN ZHEN ZLONE LIGHTING CO., LTD

www.zlonelighting.com

ENTERPRISE

In 2011, SHENZHEN ZLONE LIGHTING CO., LTD was established.

With about 10 years of rapid growing, ZLONE owns an ISO9001:2015 quality management system certificated factory ,which covers an area of 5,000 square meters, also has a modern production work that equipped with advanced production equipments such as: Full-automatic surface mounting machine, Automatic soldering machine, Advanced testing machine, Integrating sphere spectrometer, IES Testing Equipment and Dark Room ect.

Besides, ZLONE has a 5-10 year experienced engineers & technicians team in R&D, PMC, Manufacturing and QC Departments.

ZLONE's expert R&D engineers with abundant knowledge and experiences in Electric Components & LEDs, Optics, Dialux Prototype, Thermal Management and Industrial Design, so that ZLONE is capable of providing professional lighting solutions for our customer's projects world widely.

Since 2012, ZLONE has done hundreds of lighting projects domestically and abroad.

Projects cover: Warehouse, Office, Shop, Hotel, Church, Railway Station, Football Courts, Tennis Courts, Badminton Stadium...ect. Some projects located in: China, Australia, Aruba, Malaysia, Sweden, Holland, Hungary, Chile, and Russia.

No project too big or too small, we deliver exceptional results with on-time and on-budget.

In quality, ZLONE has developed its own quality inspection system by advanced Temperature testers, Luminance testers and Photoelectric instruments to conduct strict testing such as: Voltage withstand, Shock proof and Erosion tests, Lighting efficiency and performance, Waterproof...ect. All products must 100% pass those necessary tests and pass at least 12-48 hours mandatory aging tests before delivery to our customers.

ZLONE's main products are extended to: LED Panel LED Down light, LED Tri-proof Light, LED UFO high bays Light, LED Linear High bay Light, LED Gas Station Light, LED Floodlight, LED Stadium Light, and LED Solar Light.

Products are with 20 utility patents and have been approval by ENEC, SAA, C-tick, TUV, CE, ROHS, and EMC.

ZLONE's main markets are in Europe (40%), North America (10%), South America (15%), Asia (15%), Oceania (15%), others (5%)

ZLONE has skilled sales team with fluent language abilities to make sure of on-time, skilled and smooth communication.

ZLONE offers 3-5 year warranty service, during warranty period; ZLONE provides FREE spare units or FREE Replacements. Details please refer to our warranty policy.

ZLONE will strive to offer more excellent products, better lighting solutions and more professional service to all clients.

CERTIFICATE

PRODUCTS ARE WITH 20 UTILITY PATENTS

HAVE BEEN APPROVAL BY ENEC, SAA, C-tick, TUV, CE, ROHS, and EMC



ORGNIZATION

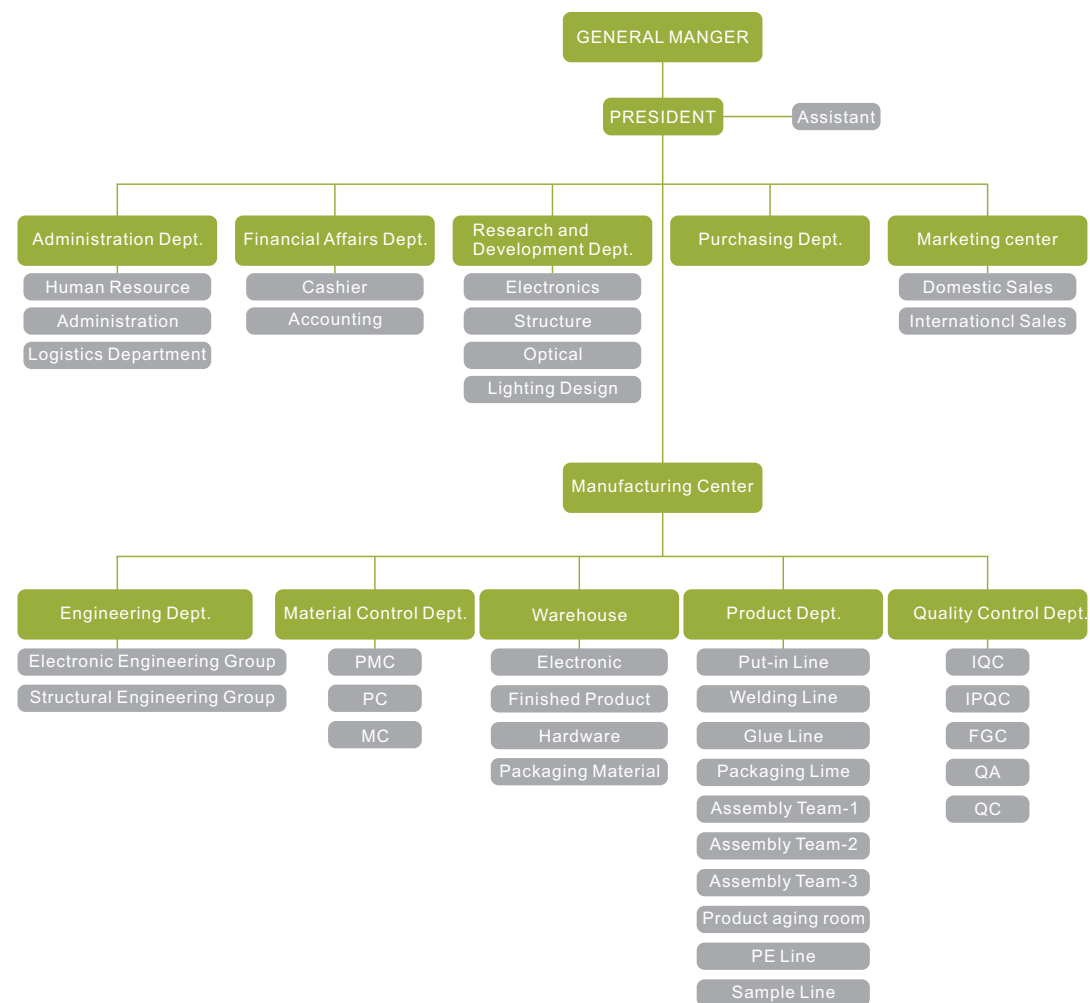

MARKET



OUR COMPANY



OUR TEAM&EXHIBITION



TESTS&EQUIPMENT

ISO9001:2015 quality management system certificated factory
has a modern production work that equipped with advanced equipment



PRODUCT DESIGN LIGHTING SIMULATION

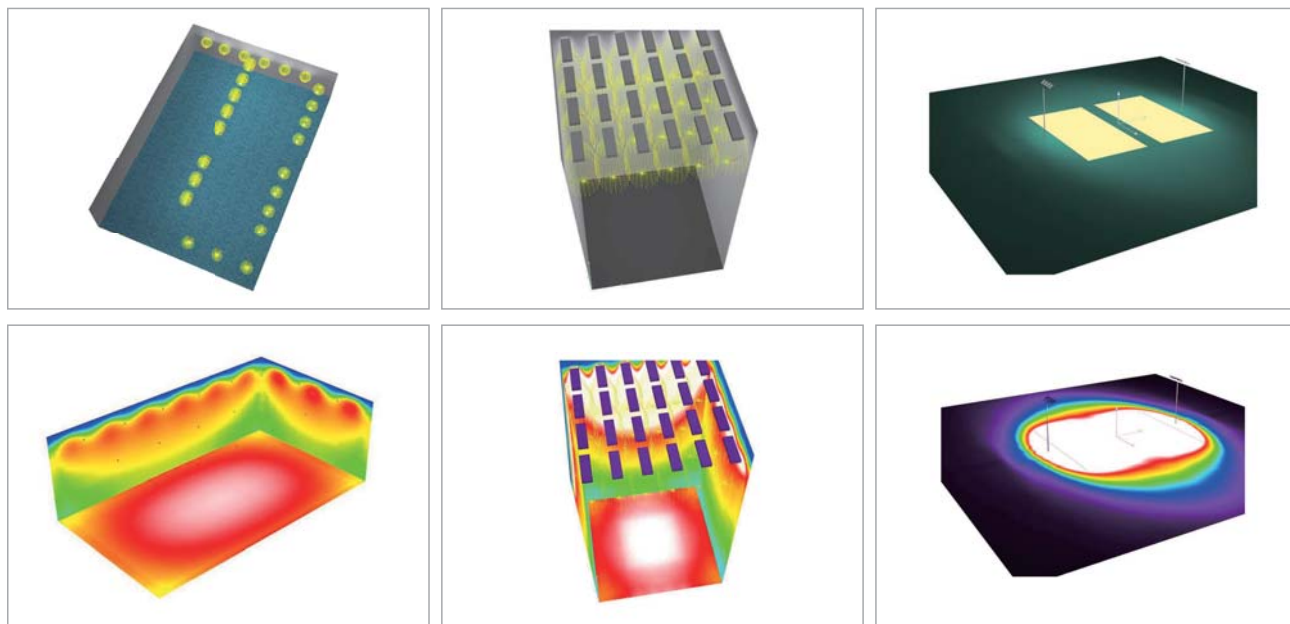

CATALOG

MULTI-FUNCTION PANEL LIGHT	01
SURFACE MOUNT LED PANEL LIGHT ROUND & SQUARE	03
RECESSED LED PANEL LIGHT ROUND & SQUARE	04
DEEP ANTI DAZZLE DOWNLIGHT	05
FREE COMBINATION DIY SERIES	07
LED DOWNLIGHT	09
WATERPROOF LED DOWN LIGHT	12
LED GIMBAL LIGHT	13
ADJUSTABLE ANGLE DOWN LIGHT	14
AW SERIES ADJUSTABLE DOWN LIGHT	15
LED SURFACE MOUNTED DOWN LIGHT	16
LED LINEAR LIGHT	18
TUYA PANEL LIGHT	20
TUYA BULB LIGHT	21
TUYA LED STRIP LIGHT	22
ELEGANT LED HIGH BAY	23
JF SERIES TRACKLIGHT	24
JN SERIES TRACKLIGHT	25
JY SERIES TRACKLIGHT	26
3/4 WIRE TRACK+ACCESSORIES	27
WATERPROOF BATTEN LIGHT	28

MULTI-FUNCTION PANEL LIGHT



DIP Switch

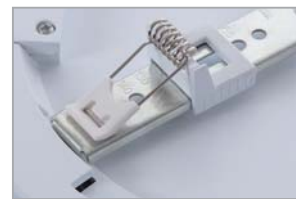

Adjustable Clip

PRODUCT FEATURES

- Radar Sensor
- 3CCT Changeable
- Cut hole size Adjustable
- Surface mounted and recessed mounted both available
- V-0 Anti-fire Plastic Housing



120°



220-240V
100-260V



Recessed



Surface



Radar Sensor



3CCT Changeable

Power	Item No.	Diameter (mm)	Height (mm)	Cut hole size(mm) For recessed mount	LED Quantity	RA	PF
9W	ZL-MPRD-9W	155	20	55-130	2835-54pcs	80	>0.9
12W	ZL-MPRD-12W	175	20	55-150	2835-72pcs	80	>0.9
18W	ZL-MPRD-18W	225	20	55-200	2835-108pcs	80	>0.9
24W	ZL-MPRD-24W	300	20	55-280	2835-150pcs	80	>0.9
9W	ZL-MPSQ-9W	155	20	55-130	2835-54pcs	80	>0.9
12W	ZL-MPSQ-12W	175	20	55-150	2835-72pcs	80	>0.9
18W	ZL-MPSQ-18W	225	20	55-200	2835-108pcs	80	>0.9
24W	ZL-MPSQ-24W	300	20	55-280	2835-150pcs	80	>0.9

SURFACE INSTALLATION INSTRUCTIONS

1. Fix the bracket on the ceiling with screws

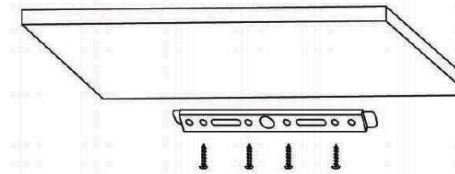

2. Push up the panel light, rotate it to fix

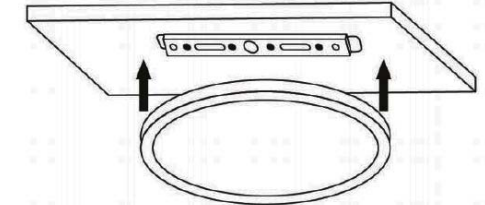

3. Rotate the panel light until it is fixed with the bracket tightly

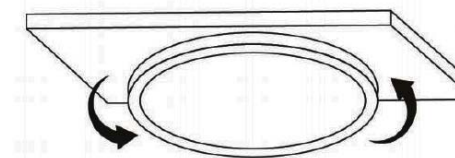

4. Turn on the light, enjoy your lighting product

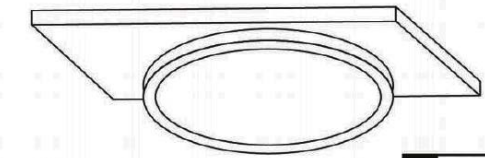

RECESSED INSTALLATION INSTRUCTIONS

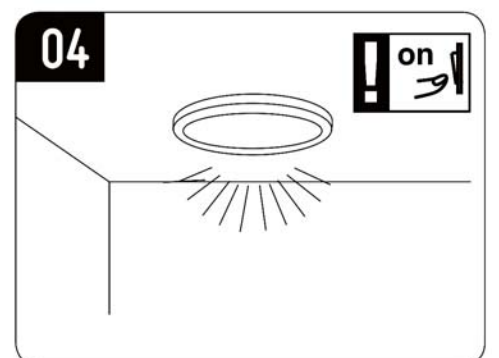
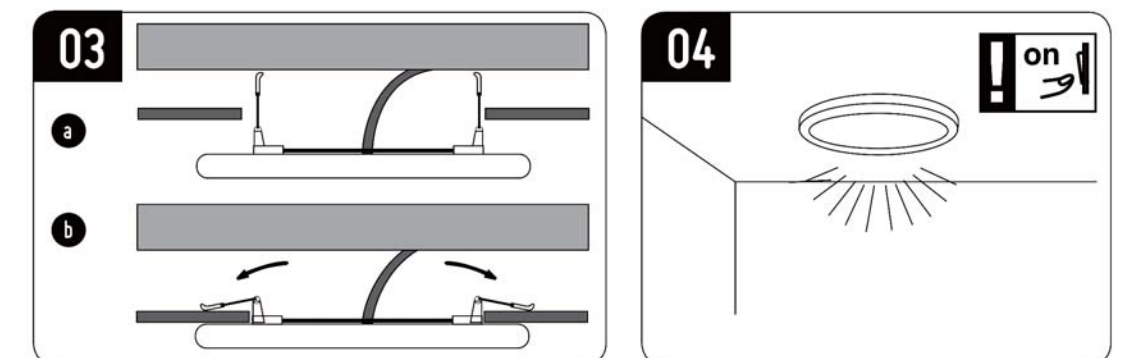
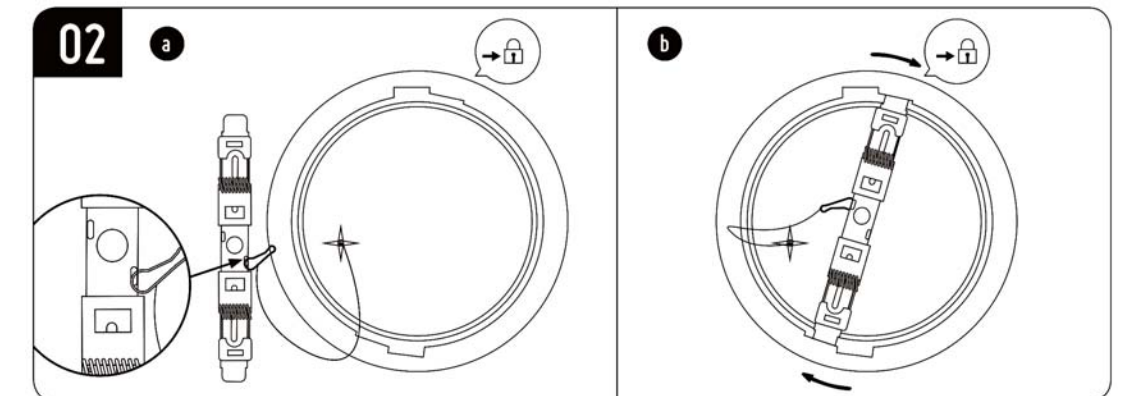
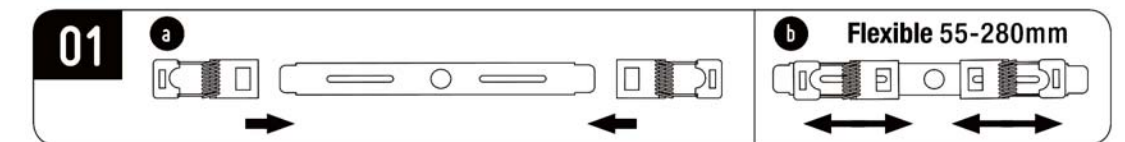

SURFACE MOUNT LED PANEL LIGHT ROUND & SQUARE



- High light efficiency
- High color index
- 120° Luminous angle
- Strong sealing
- No flicker
- DIMMABLE



Model	Power	Materials	Size(mm)	Input Voltage	CCT(K)	Chip Brand/Qty	Lamp Efficiency	Lumenious Flux	PF	CRI
ZL-RP120-6W	6W	Aluminium + PS	Φ 120*H32	AC100-260V	3000K4000K5000K6000K	30PCS/SMD2835	85-90lm/w	470LM	>0.9	Ra:80
ZL-RP170-12W	12W	Aluminium + PS	Φ 170*H32	AC100-260V	3000K4000K5000K6000K	60PCS/SMD2835	85-90lm/w	990LM	>0.9	Ra:80
ZL-RP225-18W	18W	Aluminium + PS	Φ 220*H32	AC100-260V	3000K4000K5000K6000K	90PCS/SMD2835	85-90lm/w	1530LM	>0.9	Ra:80
ZL-RP300-24W	24W	Aluminium + PS	Φ 300*H32	AC100-260V	3000K4000K5000K6000K	120PCS/SMD2835	85-90lm/w	2160LM	>0.9	Ra:80
ZL-SP120-6W	6W	Aluminium + PS	120*120*H32	AC100-260V	3000K4000K5000K6000K	30PCS/SMD2835	85-90lm/w	470LM	>0.9	Ra:80
ZL-SP170-12W	12W	Aluminium + PS	170*170*H32	AC100-260V	3000K4000K5000K6000K	60PCS/SMD2835	85-90lm/w	990LM	>0.9	Ra:80
ZL-SP225-18W	18W	Aluminium + PS	220*220*H32	AC100-260V	3000K4000K5000K6000K	90PCS/SMD2835	85-90lm/w	1530LM	>0.9	Ra:80
ZL-SP300-24W	24W	Aluminium + PS	300*300*H32	AC100-260V	3000K4000K5000K6000K	120PCS/SMD2835	85-90lm/w	2160LM	>0.9	Ra:80

RECESSED LED PANEL LIGHT ROUND & SQUARE



Model	Power	Materials	Size(mm)		Input Voltage	CCT(K)	Chip Brand/Qty	Lamp Efficiency	Lumenious Flux	PF	CRI
			Diameter	Cut-hole							
ZL-RRP-06W	6W	Aluminium + PS	Φ 120mm	105mm	AC85-265V	3000K4000K5000K6000K	30PCS/SMD2835	85-90lm/w	510LM	>0.9	Ra:80
ZL-RRP-12W	12W	Aluminium + PS	Φ 170mm	150mm	AC85-265V	3000K4000K5000K6000K	60PCS/SMD2835	85-90lm/w	990LM	>0.9	Ra:80
ZL-RRP-18W	18W	Aluminium + PS	Φ 220mm	200mm	AC85-265V	3000K4000K5000K6000K	90PCS/SMD2835	85-90lm/w	1550LM	>0.9	Ra:80
ZL-RRP-24W	24W	Aluminium + PS	Φ 300mm	280mm	AC85-265V	3000K4000K5000K6000K	120PCS/SMD2835	85-90lm/w	2160LM	>0.9	Ra:80
ZL-SRP-06W	6W	Aluminium + PS	120*120mm	105mm	AC85-265V	3000K4000K5000K6000K	30PCS/SMD2835	85-90lm/w	510LM	>0.9	Ra:80
ZL-SRP-12W	12W	Aluminium + PS	170*170mm	150mm	AC85-265V	3000K4000K5000K6000K	60PCS/SMD2835	85-90lm/w	990LM	>0.9	Ra:80
ZL-SRP-18W	18W	Aluminium + PS	220*220mm	205mm	AC85-265V	3000K4000K5000K6000K	90PCS/SMD2835	85-90lm/w	1550LM	>0.9	Ra:80
ZL-SRP-24W	24W	Aluminium + PS	300*300mm	280mm	AC85-265V	3000K4000K5000K6000K	120PCS/SMD2835	85-90lm/w	2160LM	>0.9	Ra:80

Motion sensor led panel



Emergency led panel

Emergency time:60mins to 180mins



DEEP ANTI DAZZLE DOWNLIGHT

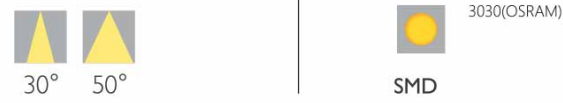

Reflector Colors

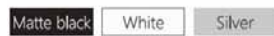

- ◆ LED Brand
CITIZEN CREE EPISTAR
- ◆ Voltage & Frequency
AC220-240V / 100-277V 150/60Hz
- ◆ Dimmable
Triac | 0-10V | DALI | TUYA
- ◆ CCT
2700K | 3000K | 4000K | 5000K
- ◆ CRI
Ra83 | Ra90 | RA97
- ◆ Lamp Efficiency
> 100lm/W
- ◆ Driver Brand
TRIDONIC OSRAM
LIFUD BRIDGELUX
- ◆ Warranty & Life span
5 years & 50,000hrs



Power: 15W
ZL-AWRI-A6
CCT:3000k 4000k 5000k
UGR: < 17
Materiel:Die casting aluminium
Color:WH/BK

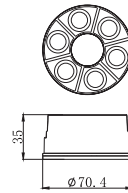

Power:20W
ZL-AWRI-A12
CCT:3000k 4000k 5000k
UGR: < 17
Materiel:Die casting aluminium
Color:WH/BK

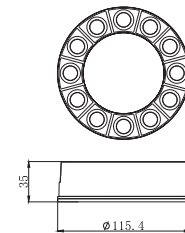

Power:30W
ZL-AWRI-A18
CCT:3000k 4000k 5000k
UGR: < 17
Materiel:Die casting aluminium
Color:WH/BK

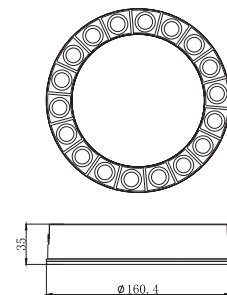

DEEP ANTI DAZZLE DOWNLIGHT



Power:8W
ZL-AWRI-A6
CCT:3000k 4000k 5000k
UGR: < 17
Materiel:Die casting aluminium
Color:WH/BK

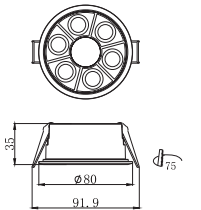

Power: 15W
ZL-AWRI-A12
CCT:3000k 4000k 5000k
UGR: < 17
Materiel:Die casting aluminium
Color:WH/BK

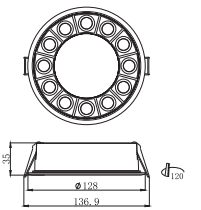

Power:20W
ZL-AWRI-A18
CCT:3000k 4000k 5000k
UGR: < 17
Materiel:Die casting aluminium
Color:WH/BK

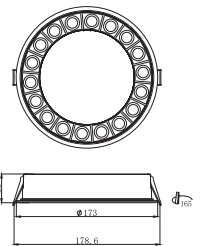

Power:
ZL-AWRI-A24
CCT:3000k 4000k 5000k
UGR: < 17
Materiel:Die casting aluminium
Color:WH/BK

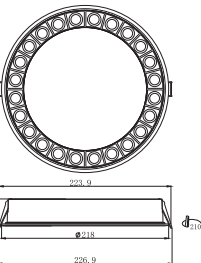

Cree chips hacc longer life
High CRI, longer service life



FREE COMBINATION DIY SERIES

DIY SERIES

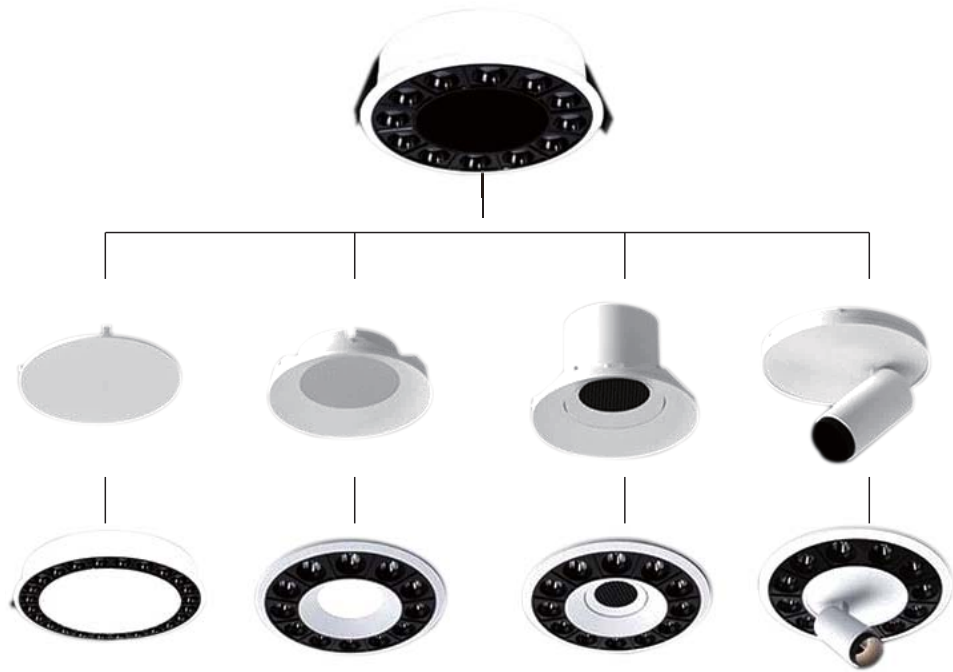

Power: 15+7W
ZL-AWRI-B12
CCT:3000k 4000k 5000k
UGR: < 17
Materiel:Die casting aluminrium
Color:WH/BK

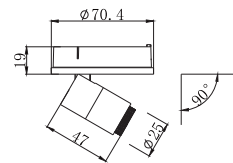

Power:20+12W
ZL-AWRI-B18
CCT:3000k 4000k 5000k
UGR: < 17
Materiel:Die casting aluminrium
Color:WH/BK

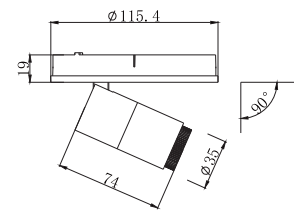

Power:30+20W
ZL-AWRI-B24
CCT:3000k 4000k 5000k
UGR: < 17
Materiel:Die casting aluminrium
Color:WH/BK

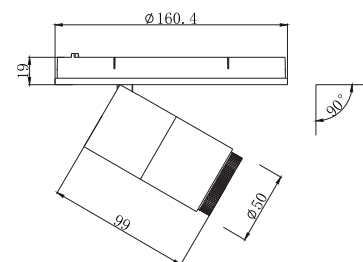

Power: 15+7W
ZL-AWRI-B12
CCT:3000k 4000k 5000k
UGR: < 17
Materiel:Die casting aluminrium
Color:WH/BK

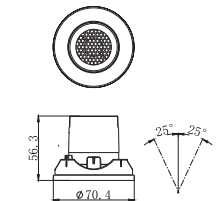

Power:20+12W
ZL-AWRI-B18
CCT:3000k 4000k 5000k
UGR: < 17
Materiel:Die casting aluminrium
Color:WH/BK

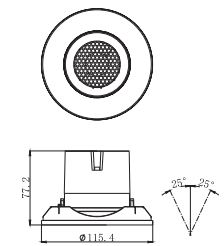

Power:30+20W
ZL-AWRI-B24
CCT:3000k 4000k 5000k
UGR: < 17
Materiel:Die casting aluminrium
Color:WH/BK

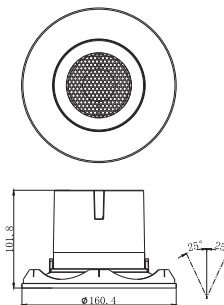

Power: 15+3W/20+8W/30+15W
CCT:3000k 4000k 5000k
UGR: < 17
Materiel:Die casting aluminrium
Color:WH/BK

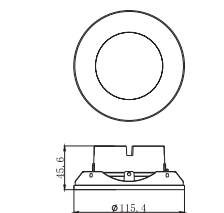

LED DOWNLIGHT

DXS Series

UGR<19



◆ LED Brand
CITIZEN CREE EPISTAR

◆ Dimmable
Triac | 0-10V | DALI | TUYA

◆ CRI
Ra83 | Ra90 | RA97

◆ Driver Brand
TRIDONIC OSRAM
LIFUD BRIDGELUX

◆ BeamAngle
60°

◆ Voltage & Frequency
AC220-240V / 100-277V | 50/60Hz

◆ CCT
2700K | 3000K | 4000K | 5000K

◆ Certificate
CB | CE | RoHS | SAA | TUV | SGS

◆ Warranty & Life span
5 years & 50,000hrs

◆ Finish Color
White ○ Black ● Silver ○

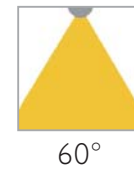

Model	Power	Size(mm)	Cut-hole (mm)	Efficiency	Beam Angle	LED	LED Driver
ZL-DXS2.5-7W	7W	φ 90*45	φ 70	110lm/w	60°	COB OSRAM/ CITIZEN/CREE	OSRAM /LIFUD
ZL-DXS3-10W	10W	φ 105*65	φ 85	110lm/w	60°	COB OSRAM/ CITIZEN/CREE	OSRAM /LIFUD
ZL-DXS4-15W	15W	φ 130*68	φ 105	110lm/w	60°	COB OSRAM/ CITIZEN/CREE	OSRAM /LIFUD
ZL-DXS5-20W	20W	φ 165*90	φ 140	110lm/w	60°	COB OSRAM/ CITIZEN/CREE	OSRAM /LIFUD
ZL-DXS6-30W	30W	φ 185*95	φ 165	110lm/w	60°	COB OSRAM/ CITIZEN/CREE	OSRAM /LIFUD
ZL-DXS8-40W	40W	φ 220*105	φ 200	110lm/w	60°	COB OSRAM/ CITIZEN/CREE	OSRAM /LIFUD

LED DOWNLIGHT

DXK Series

UGR<19



◆ LED Brand
CITIZEN CREE EPISTAR

◆ Dimmable
Triac | 0-10V | DALI | TUYA

◆ CRI
Ra83 | Ra90 | RA97

◆ Driver Brand
TRIDONIC OSRAM
LIFUD BRIDGELUX

◆ BeamAngle
60°

◆ Voltage & Frequency
AC220-240V / 100-277V | 50/60Hz

◆ CCT
2700K | 3000K | 4000K | 5000K

◆ Certificate
CB | CE | RoHS | SAA | TUV | SGS

◆ Warranty & Life span
5 years & 50,000hrs

◆ Finish Color
White ○ Black ● Silver ○

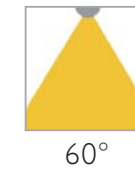

Model	Power	Size(mm)	Cut-hole (mm)	Efficiency	Beam Angle	LED	LED Driver
ZL-DXK2.5-7W	7W	φ 90*50	φ 70	110lm/w	60°	SMD 2835 or COB OSRAM/ CITIZEN/CREE	OSRAM /LIFUD
ZL-DXK3-10W	10W	φ 105*53	φ 85	110lm/w	60°	SMD 2835 or COB OSRAM/ CITIZEN/CREE	OSRAM /LIFUD
ZL-DXK4-15W	15W	φ 120*62	φ 100	110lm/w	60°	SMD 2835 or COB OSRAM/ CITIZEN/CREE	OSRAM /LIFUD
ZL-DXK5-20W	20W	φ 160*73	φ 140	110lm/w	60°	SMD 2835 or COB OSRAM/ CITIZEN/CREE	OSRAM /LIFUD
ZL-DXK6-30W	30W	φ 190*82	φ 170	110lm/w	60°	SMD 2835 or COB OSRAM/ CITIZEN/CREE	OSRAM /LIFUD
ZL-DXK8-40W	40W	φ 220*95	φ 200	110lm/w	60°	SMD 2835 or COB OSRAM/ CITIZEN/CREE	OSRAM /LIFUD

LED DOWNLIGHT

XJFX Series

UGR<19



- ◆ LED Brand
CITIZEN CREE EPISTAR
- ◆ Dimmable
Triac | 0-10V | DALI
- ◆ CRI
Ra83 | Ra90 | RA97
- ◆ Driver Brand
TRIDONIC OSRAM
LIFUD BRIDGELUX
- ◆ Beam Angle
110°
- ◆ Voltage & Frequency
AC220-240V / 100-277V | 50/60Hz
- ◆ CCT
2700K | 3000K | 4000K | 5000K
- ◆ Certificate
CB | CE | RoHS | SAA | TUV | SGS
- ◆ Warranty & Life span
5 years & 50,000hrs
- ◆ Finish Color
White ○ Black ● Silver ○



Model	Power	Size(mm)	Cut-hole (mm)	Efficiency	Beam Angle	LED	LED Driver
ZL-XJFX- 7W	7W	φ 90*35	φ 75	110lm/w	110°	SMD 2835	OSRAM /LIFUD
ZL-XJFX- 12W	12W	φ 120*35	φ 95	110lm/w	110°	SMD 2835	OSRAM /LIFUD
ZL-XJFX- 15W	15W	φ 145*35	φ 120	110lm/w	110°	SMD 2835	OSRAM /LIFUD
ZL-XJFX- 20W	20W	φ 175*35	φ 150	110lm/w	110°	SMD 2835	OSRAM /LIFUD
ZL-XJFX- 30W	30W	φ 220*35	φ 200	110lm/w	110°	SMD 2835	OSRAM /LIFUD

WATERPROOF LED DOWN LIGHT

IP65



- ◆ LED Brand
CITIZEN CREE EPISTAR
- ◆ Dimmable
Triac | 0-10V | DALI | TUYA
- ◆ CRI
Ra83 | Ra90 | RA97
- ◆ Driver Brand
TRIDONIC OSRAM
LIFUD BRIDGELUX
- ◆ Beam Angle
38° | 60°
- ◆ Voltage & Frequency
AC220-240V / 100-277V | 50/60Hz
- ◆ CCT
2700K | 3000K | 4000K | 5000K
- ◆ Certificate
CB | CE | RoHS | SAA | TUV | SGS
- ◆ Warranty & Life span
5 years & 50,000hrs
- ◆ Finish Color
White ○ Black ● Silver ○



Model	Power	Size(mm)	Cut-hole (mm)	IP Rate	Beam Angle	LED	LED Driver
ZL-DXWP- 7W	7W	φ 110*65	φ 95	IP65	38°/60°	COB OSRAM/CITIZEN/CREE	OSRAM /LIFUD
ZL-DXWP- 10W	10W	φ 130*71	φ 115	IP65	38°/60°	COB OSRAM/CITIZEN/CREE	OSRAM /LIFUD
ZL-DXWP- 15W	15W	φ 165*82	φ 140	IP65	38°/60°	COB OSRAM/CITIZEN/CREE	OSRAM /LIFUD
ZL-DXWP- 20W	20W	φ 190*100	φ 170	IP65	38°/60°	COB OSRAM/CITIZEN/CREE	OSRAM /LIFUD
ZL-DXWP- 30W	30W	φ 230*117	φ 200	IP65	38°/60°	COB OSRAM/CITIZEN/CREE	OSRAM /LIFUD

LED GIMBAL LIGHT

360° rotatable
7-50W COB led gimbal light



- ◆ LED Brand
CITIZEN CREE EPISTAR
- ◆ Dimmable
Triac | 0-10V | DALI
- ◆ CRI
Ra83 | Ra90 | Ra97
- ◆ Driver Brand
TRIDONIC OSRAM
LIFUD BRIDGELUX
- ◆ Beam Angle
15°/24°/38°
- ◆ Voltage & Frequency
AC220-240V / 100-277V | 50/60Hz
- ◆ CCT
2700K | 3000K | 4000K | 5000K
- ◆ Certificate
CB | CE | RoHS | SAA | TUV | SGS
- ◆ Warranty & Life span
5 years & 50,000hrs
- ◆ Finish Color
White ○ Black ● Silver ○

Cutting size	75-80mm	92-95mm	110-115mm	125-130mm	145-150mm	175-180mm
	ZL-GML-10W Power: 10W Size: 90*H60	ZL-GML-15W Power: 15W Size: 102*H80	ZL-GML20W Power: 20W Size: 125*H108	ZL-GML-30W Power: 30W Size: 140*H115	ZL-GML-40W Power: 40W Size: 160*H135	ZL-GML-50W Power: 50W Size: 190*H170

Item no.	Power	COB LED	CRI	Color Kelvin (optional)	Lamp Illumination	Voltage	Beam angle (optional)	Driver Brand	Dimension (mm)
ZL-GML-10W	10W	CREE/Osram	80	2700K/3000K/4000K/5000K/6500K	950-1000lm	AC220-240V	15° 24° 38°	Lifud/Osram	φ90*H60 φ75-80(hole)
ZL-GML-15W	15W	CREE/Osram	80	2700K/3000K/4000K/5000K/6500K	1500-1600lm	AC220-240V	15° 24° 38°	Lifud/Osram	φ102*H80 φ92-95(hole)
ZL-GML-20W	20W	CREE/Osram	80	2700K/3000K/4000K/5000K/6500K	2000-2200lm	AC220-240V	15° 24° 38°	Lifud/Osram	φ125xH108 φ110-115(hole)
ZL-GML-30W	30W	CREE/Osram	80	2700K/3000K/4000K/5000K/6500K	3000-3300lm	AC220-240V	15° 24° 38°	Lifud/Osram	φ140xH115 φ125-130(hole)
ZL-GML-40W	40W	CREE/Osram	80	2700K/3000K/4000K/5000K/6500K	4000-4300lm	AC220-240V	15° 24° 38°	Lifud/Osram	φ160xH135 φ145-150(hole)
ZL-GML-50W	50W	CREE/Osram	80	2700K/3000K/4000K/5000K/6500K	5000-5300lm	AC220-240V	15° 24° 38°	Lifud/Osram	φ190xH170 φ175-180(hole)

ADJUSTABLE ANGLE DOWN LIGHT

UP and down retraction freely

The lamp cap can be expanded at will, bringing you more impressive lighting

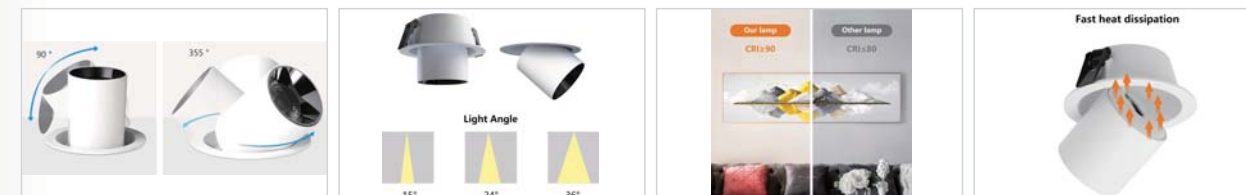

Model	Power	Size(mm)	Cut-hole (mm)	Efficiency	Beam Angle	LED	LED Driver
ZL-WX-100	10W	φ115*H84	φ95	110lm/w	15°/24°/36°	COB OSRAM/CITIZEN/CREE	OSRAM/LIFUD
ZL-WX-170	17W	φ190*H124	φ170	110lm/w	15°/24°/36°	COB OSRAM/CITIZEN/CREE	OSRAM/LIFUD

AW SERIES ADJUSTABLE DOWN LIGHT

LED SURFACE MOUNTED DOWN LIGHT



Available Colors



- Power: 7w/12w/20w
- Input: 200-240VAC, 50/60HZ
- RA: 90
- Material: Die casting Aluminum
- Warranty: 3 years
- Beam: 18°/24°/36°
- Features: Low UGR; Flexible optic changes
- Application: Office, hotel, showroom, etc

PRODUCT ANALYSIS



Model	Power	Size(mm)	Cut-hole (mm)	Efficiency	Beam Angle	LED	LED Driver
ZL-AWR60-5W	7W	φ 65*84	φ 60	110lm/w	18°/24°/36°	COB OSRAM/CITIZEN/CREE	OSRAM/LIFUD
ZL-AWR80-12W	12W	φ 87.5*108	φ 80	110lm/w	18°/24°/36°	COB OSRAM/CITIZEN/CREE	OSRAM/LIFUD
ZL-AWR100-20W	20W	φ 110*130	φ 100	110lm/w	18°/24°/36°	COB OSRAM/CITIZEN/CREE	OSRAM/LIFUD
ZL-AWS60-5W	7W	65*65*84	φ 60*60	110lm/w	18°/24°/36°	COB OSRAM/CITIZEN/CREE	OSRAM/LIFUD
ZL-AWS80-12W	12W	87.5*87.5*108	φ 80*80	110lm/w	18°/24°/36°	COB OSRAM/CITIZEN/CREE	OSRAM/LIFUD
ZL-AWS100-20W	20W	110*110*130	φ 100*100	110lm/w	18°/24°/36°	COB OSRAM/CITIZEN/CREE	OSRAM/LIFUD



AWSD Series

Model	Power	Size(mm)	Beam Angle	CRI(Ra)	LED Brand	Lumen
ZL-AWSD-15W	15W	φ 119*45	20°/34°/48°	80/90	OSRAM/CITIZEN/CREE	1650lm
ZL-AWSD-20W	20W	φ 164*45	20°/34°/48°	80/90	OSRAM/CITIZEN/CREE	2200lm
ZL-AWSD-30W	30W	φ 209*45	20°/34°/48°	80/90	OSRAM/CITIZEN/CREE	3300lm



DXR Series

Model	Power	Size(mm)	Beam Angle	CRI(Ra)	LED Brand	Lumen
ZL-DXR-10W	10W	φ 94*110	15°/ 24°/36°	80/90	OSRAM/CITIZEN/CREE	1100lm
ZL-DXR-15W	15W	φ 114*121	15°/ 24°/36°	80/90	OSRAM/CITIZEN/CREE	1650lm
ZL-DXR-20W	20W	φ 141*141	15°/ 24°/36°	80/90	OSRAM/CITIZEN/CREE	2200lm
ZL-DXR-30W	30W	φ 170*161	15°/ 24°/36°	80/90	OSRAM/CITIZEN/CREE	3300lm
ZL-DXR-50W	50W	φ 204*181	15°/ 24°/36°	80/90	OSRAM/CITIZEN/CREE	5500lm



DXS Series

Model	Power	Size(mm)	Beam Angle	CRI(Ra)	LED Brand	Lumen
ZL-DXS-10W	10W	φ 93*93*90	15°/ 24°/36°	80/90	OSRAM/CITIZEN/CREE	1100lm
ZL-DXS-20W	20W	φ 174*94*90	15°/ 24°/36°	80/90	OSRAM/CITIZEN/CREE	2200lm
ZL-DXS-30W	30W	φ 256*94*90	15°/ 24°/36°	80/90	OSRAM/CITIZEN/CREE	3300lm
ZL-DXS-40W	40W	φ 174*174*90	15°/ 24°/36°	80/90	OSRAM/CITIZEN/CREE	4400lm

LED SURFACE MOUNTED DOWN LIGHT

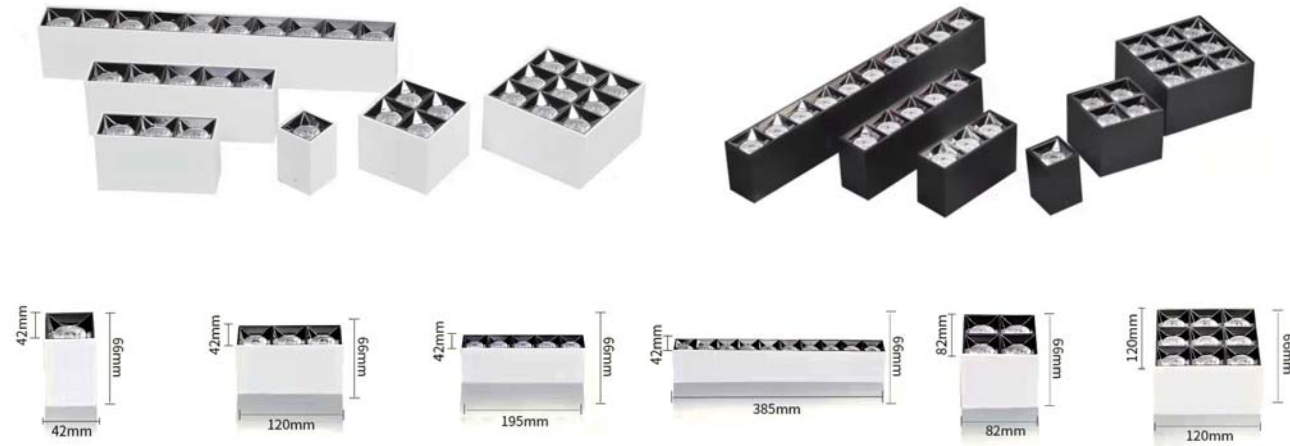

Model	Power	Size(mm)	Beam Angle	CRI(Ra)	LED Brand	Lumen
ZL-DXC-3W	3-4W	42*42*66	15°/ 24°/36°	80/90	OSRAM/CITIZEN/CREE	400lm
ZL-DXC-12W	12W	120*42*66	15°/ 24°/36°	80/90	OSRAM/CITIZEN/CREE	1320lm
ZL-DXC-14W	14W	82*82*66	15°/ 24°/36°	80/90	OSRAM/CITIZEN/CREE	1540lm
ZL-DXC-20W	20W	195*42*66	15°/ 24°/36°	80/90	OSRAM/CITIZEN/CREE	2200lm
ZL-DXC-30W	30W	120*120*66	15°/ 24°/36°	80/90	OSRAM/CITIZEN/CREE	3300lm
ZL-DXC-40W	40W	385*42*66	15°/ 24°/36°	80/90	OSRAM/CITIZEN/CREE	4400lm



Model	Power	Size(mm)	Beam Angle	CRI(Ra)	LED Brand	Lumen
ZL-DXY-9W	10W	φ93*93*90	15°/ 24°/36°	80/90	OSRAM/CITIZEN/CREE	1100lm
ZL-DXY-12W	10W	φ93*93*90	15°/ 24°/36°	80/90	OSRAM/CITIZEN/CREE	1100lm
ZL-DXF-9W	20W	φ174*94*90	15°/ 24°/36°	80/90	OSRAM/CITIZEN/CREE	2200lm
ZL-DXF-12W	20W	φ174*94*90	15°/ 24°/36°	80/90	OSRAM/CITIZEN/CREE	2200lm

LED LINEAR LIGHT



Model	Power	Efficiency	Beam Angle	Size(mm)	Installation
ZL-LL3470-10W	10W	100lm/w	15°/ 30°/45°	136.5*34*70	Surface/Suspended
ZL-LL3470-20W	20W	100lm/w	15°/ 30°/45°	269*34*70	Surface/Suspended
ZL-LL3470-30W	30W	100lm/w	15°/ 30°/45°	402*34*70	Surface/Suspended

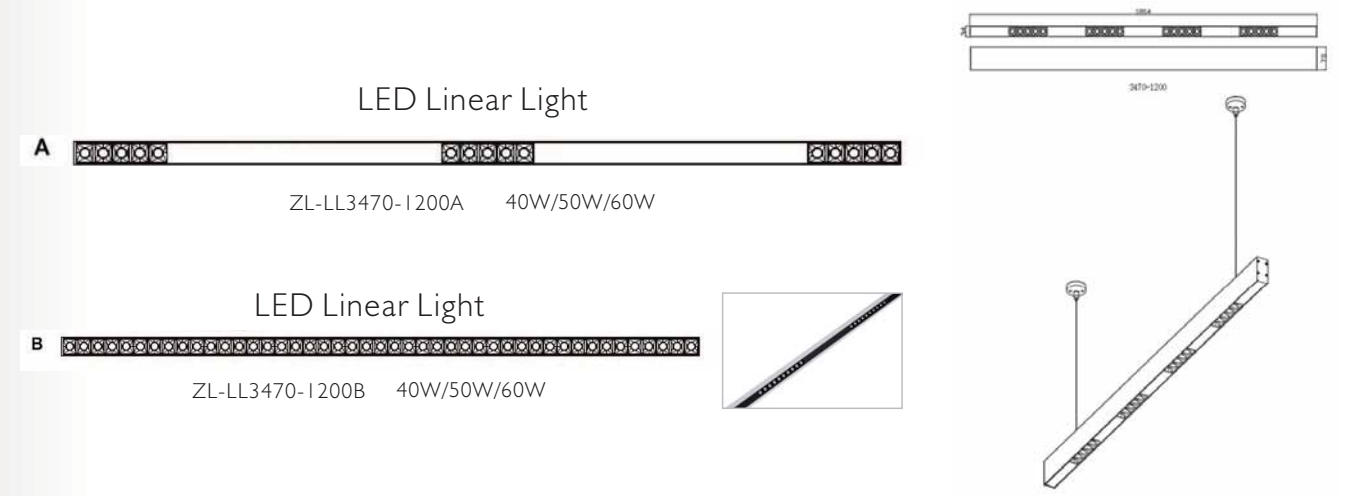

LED LINEAR LIGHT

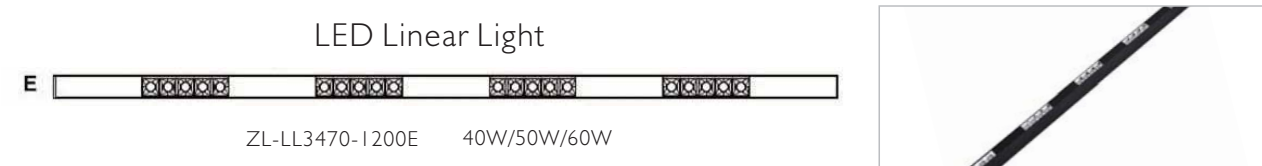
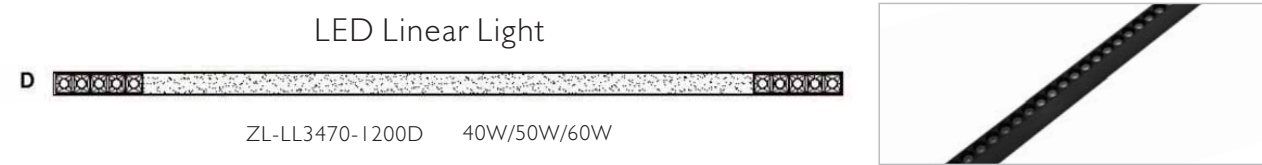
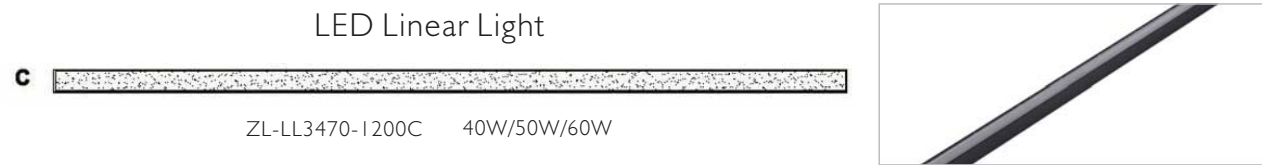

Model	Power	Efficiency	Beam Angle	Size(mm)	Installation
ZL-LL3470-1200A	40W/50W/60W	100lm/w	15°/ 30°/45°	1196*34*70	Surface/Suspended
ZL-LL3470-1200B	40W/50W/60W	100lm/w	15°/ 30°/45°	1196*34*70	Surface/Suspended
ZL-LL3470-1200C	40W/50W/60W	100lm/w	15°/ 30°/45°	1196*34*70	Surface/Suspended
ZL-LL3470-1200D	40W/50W/60W	100lm/w	15°/ 30°/45°	1196*34*70	Surface/Suspended
ZL-LL3470-1200E	40W/50W/60W	100lm/w	15°/ 30°/45°	1196*34*70	Surface/Suspended



TUYA PANEL LIGHT

- High light efficiency
- No radiation
- High color index
- No flicker
- Tuya Intelligence
- Energy saving



Model & Power	Diameter(mm)	Cut-hole(mm)	TUYA Control	Color	Input Voltage
ZL-TYAY5-6W	∅120	∅105	WIFI / Bluetooth	2700-6500K & RGB	AC100-265V
ZL-TYAY5-12W	∅170	∅150	WIFI / Bluetooth	2700-6500K & RGB	AC100-265V
ZL-TYAY5-18W	∅220	∅200	WIFI / Bluetooth	2700-6500K & RGB	AC100-265V
ZL-TYAY5-24W	∅300	∅280	WIFI / Bluetooth	2700-6500K & RGB	AC100-265V
ZL-TYAF5-6W	120*120	105*105	WIFI / Bluetooth	2700-6500K & RGB	AC100-265V
ZL-TYAF5-12W	170*170	150*150	WIFI / Bluetooth	2700-6500K & RGB	AC100-265V
ZL-TYAF5-18W	220*220	200*200	WIFI / Bluetooth	2700-6500K & RGB	AC100-265V
ZL-TYAF5-24W	300*300	280*280	WIFI / Bluetooth	2700-6500K & RGB	AC100-265V
ZL-TYMY5-6W	∅120		WIFI / Bluetooth	2700-6500K & RGB	AC100-265V
ZL-TYMY5-12W	∅170		WIFI / Bluetooth	2700-6500K & RGB	AC100-265V
ZL-TYMY5-18W	∅223		WIFI / Bluetooth	2700-6500K & RGB	AC100-265V
ZL-TYMY5-24W	∅300		WIFI / Bluetooth	2700-6500K & RGB	AC100-265V
ZL-TYMF5-6W	121*121		WIFI / Bluetooth	2700-6500K & RGB	AC100-265V
ZL-TYMF5-12W	172*172		WIFI / Bluetooth	2700-6500K & RGB	AC100-265V
ZL-TYMF5-18W	224*224		WIFI / Bluetooth	2700-6500K & RGB	AC100-265V
ZL-TYMF5-24W	300*300		WIFI / Bluetooth	2700-6500K & RGB	AC100-265V

TUYA BULB LIGHT



High light efficiency



No radiation



High color index



No flicker

Tuya

Tuya Intelligence



Energy saving

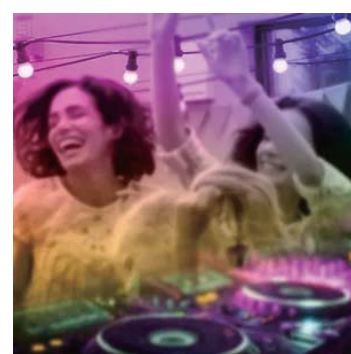
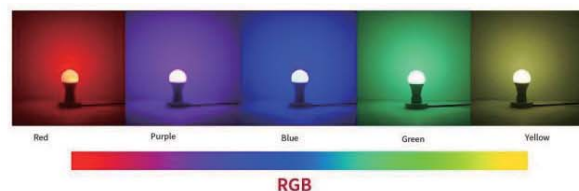

Model	Input Voltage	Control Way	PF	CRI	LED Base	pcs/CTN	Carton Size
ZL-TYA60-9W	AC100-265V	Bluetooth /Wifi	>0.9	80	E27/E26/E14/B22	100	46.5*32*32
ZL-TYA70-12W	AC100-265V	Bluetooth /Wifi	>0.9	80	E27/E26/E14/B22	50	37*37*28.5
ZL-TYA70-15W	AC100-265V	Bluetooth /Wifi	>0.9	80	E27/E26/E14/B22	50	37*37*28.5

TUYA LED STRIP LIGHT



High light efficiency



No radiation



High color index



No flicker

Tuya

Tuya Intelligence



Energy saving



P/N	PCB Width	LED Qty/ Meter	Input Voltage	Meter/ Reel	TUYA Control	pcs/ CTN	Packing Size	Waterproof
ZL-50RGB-B30D	10mm	30D	12V	15M/Reel	Bluetooth R.G.B Color	20PCS	48*33*19	Waterproof & Non-Waterproof
ZL-50RGB-B60D	10mm	60D	12V	15M/Reel	Bluetooth R.G.B Color	20PCS	48*33*19	Waterproof & Non-Waterproof
ZL-50RGB-W30D	10mm	30D	12V	15M/Reel	WIFIR.G.B Color	20PCS	48*33*19	Waterproof & Non-Waterproof
ZL-50RGB-W60D	10mm	60D	12V	15M/Reel	WIFIR.G.B Color	20PCS	48*33*19	Waterproof & Non-Waterproof
ZL-50RGBW-W60D	12mm	60D	12V	15M/Reel	WIFIR.G.B.W Color	20PCS	48*33*19	Waterproof & Non-Waterproof
ZL-50RGBWW-W60D	12mm	60D	12V	15M/Reel	WIFIR.G.B.W.W Color	20PCS	48*33*19	Waterproof & Non-Waterproof

ELEGANT LED HIGH BAY



High strength PC lens, Achieve IK08, Anti-UV, transmittance > 94%

Multiple lighting distribution :60°/90°/110°

Top brand LED chip and driver, ensure the product quality and lifetime.

Die-casting technology by ADC12, Excellent thermal management, reduce the temperature difference and ensure the lumen depreciation

Ingress Protection Rating: IP66

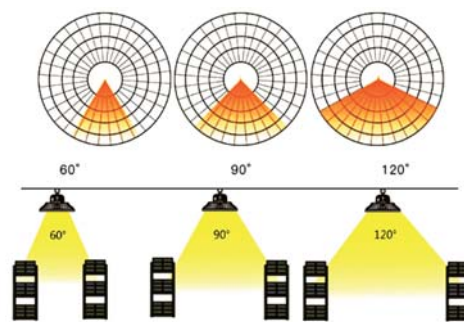

Part No	Power	CCT	Flux	Beam Angle	weight	Dimming/optional
ZL-UFOY8-100W	100W	3000K-6000K	17000LM	60°/90°/120°	2kgs	0-10V/DALI/Zigbee
ZL-UFOY8-150W	150W	3000K-6000K	25500LM	60°/90°/120°	2.5kgs	0-10V/DALI/Zigbee
ZL-UFOY8-200W	200W	3000K-6000K	34000LM	60°/90°/120°	3kgs	0-10V/DALI/Zigbee
ZL-UFOY8-240W	240W	3000K-6000K	40800LM	60°/90°/120°	3.5kgs	0-10V/DALI/Zigbee



JF SERIES TRACKLIGHT

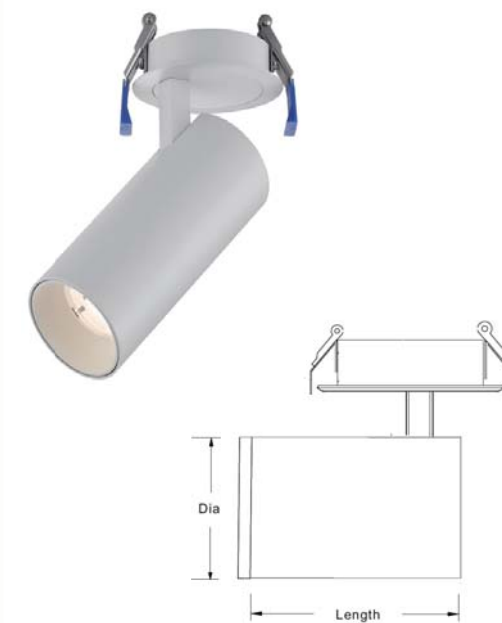

- ◆ LED Brand
CITIZEN CREE EPISTAR
- ◆ Dimmable
Triac | 0-10V | DALI | TUYA
- ◆ CRI
Ra83 | Ra90 | RA97
- ◆ Driver Brand
TRIDONIC OSRAM
LIFED BRIDGELUX
- ◆ Beam Angle
15° | 24° | 36° | 60°
- ◆ Voltage & Frequency
AC220-240V / 100-277V | 50/60Hz
- ◆ CCT
2700K | 3000K | 4000K | 5000K
- ◆ Certificate
CB | CE | RoHS | SAA | TUV | SGS
- ◆ Warranty & Life span
5 years & 50,000hrs
- ◆ Finish Color
White ○ Black ● Silver ○

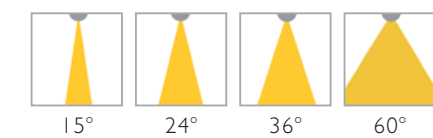

Specification

Model	Power	CRI	CCT	PF	Input Voltage	Beam Angle	Dimension (mm)
ZL-JF-10W	10W	>80/90	2700K-6000K	>0.9	AC220-240V	15°/24°/36°/60°	φ 60*L190
ZL-JF-15W	15W	>80/90	2700K-6000K	>0.9	AC220-240V	15°/24°/36°/60°	φ 60*L190
ZL-JF-20W	20W	>80/90	2700K-6000K	>0.9	AC220-240V	15°/24°/36°/60°	φ 70*L210
ZL-JF-30W	30W	>80/90	2700K-6000K	>0.9	AC220-240V	15°/24°/36°/60°	φ 80*L210
ZL-JF-35W	35W	>80/90	2700K-6000K	>0.9	AC220-240V	15°/24°/36°/60°	φ 90*L210
ZL-JF-40W	40W	>80/90	2700K-6000K	>0.9	AC220-240V	15°/24°/36°/60°	φ 90*L210

Application

Shop, cloth store, display window, museum and so on.



JN SERIES TRACKLIGHT

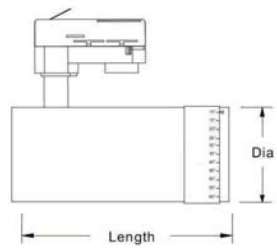

◆ LED Brand
CITIZEN CREE EPISTAR

◆ Dimmable
Triac I 0-10V I DALI

◆ CRI
Ra83 I Ra90 I RA97

◆ Driver Brand
TRIDONIC OSRAM
LIFUD BRIDGELUX

◆ Beam Angle
10° I 60°

◆ Voltage & Frequency
AC220-240V / 100-277V I 50/60Hz

◆ CCT
2700K I 3000K I 4000K I 5000K

◆ Certificate
CB I CE I RoHS I SAA I TUV I SGS

◆ Warranty & Life span
5 years & 50,000hrs

◆ Finish Color
White ○ Black ● Silver ○

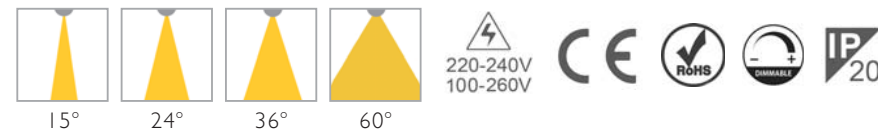

Beam Angle 10-60°

Specification

Model	Power	CRI	CCT	PF	Input Voltage	Beam Angle	Dimension (mm)
ZL-JN-10W	10W	>80/90	2700K-6000K	>0.9	AC220-240V	15°/24°/36°/60°	φ50*L160
ZL-JN-15W	15W	>80/90	2700K-6000K	>0.9	AC220-240V	15°/24°/36°/60°	φ60*L170
ZL-JN-20W	20W	>80/90	2700K-6000K	>0.9	AC220-240V	15°/24°/36°/60°	φ70*L180
ZL-JN-30W	30W	>80/90	2700K-6000K	>0.9	AC220-240V	15°/24°/36°/60°	φ90*L180
ZL-JN-35W	35W	>80/90	2700K-6000K	>0.9	AC220-240V	15°/24°/36°/60°	φ90*L180
ZL-JN-40W	40W	>80/90	2700K-6000K	>0.9	AC220-240V	15°/24°/36°/60°	φ110*L200
ZL-JN-50W	50W	>80/90	2700K-6000K	>0.9	AC220-240V	15°/24°/36°/60°	φ110*L200

Application

Museums, galleries, hotels, furniture stores, high-end clubs, villas, etc.



JY SERIES TRACKLIGHT

◆ LED Brand
CITIZEN CREE EPISTAR

◆ Dimmable
Triac I 0-10V I DALI

◆ CRI
Ra83 I Ra90 I RA97

◆ Driver Brand
TRIDONIC OSRAM
LIFUD BRIDGELUX

◆ Beam Angle
15° I 24° I 36° I 60°

◆ Voltage & Frequency
AC220-240V / 100-277V I 50/60Hz

◆ CCT
2700K I 3000K I 4000K I 5000K

◆ Certificate
CB I CE I RoHS I SAA I TUV I SGS

◆ Warranty & Life span
5 years & 50,000hrs

◆ Finish Color
White ○ Black ● Silver ○

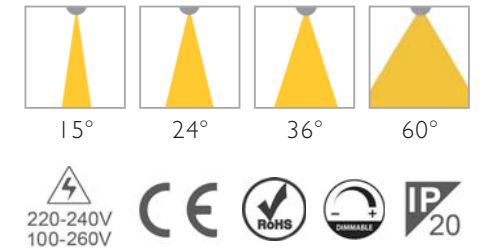

Specification

Model	Power	CRI	CCT	PF	Input Voltage	Beam Angle	Dimension (mm)
ZL-JY-10W	10W	>80/90	2700K-6000K	>0.9	AC220-240V	15°/24°/36°/60°	φ55*L140
ZL-JY-20W	20W	>80/90	2700K-6000K	>0.9	AC220-240V	15°/24°/36°/60°	φ65*L160
ZL-JY-25W	25W	>80/90	2700K-6000K	>0.9	AC220-240V	15°/24°/36°/60°	φ75*L180
ZL-JY-30W	30W	>80/90	2700K-6000K	>0.9	AC220-240V	15°/24°/36°/60°	φ75*L180



3/4 WIRE TRACK+ACCESSORIES



FEATURES AND SPECIFICATION

- copper wires(conductors),secured in an insulating (polycarbonate)retainer
- The configuration of the I,L,T and X connectors prevents any connection either with another connector(listed below)
- Aluminium body,powder coated in white or black
- Available in three lengths of 1m, 1.5m and 2m

FEATURES AND SPECIFICATION

- Live and dead ends included with each length of track
Available in three lengths: 1m, 1.5m or 2m

Model	QTY/CTN	CTN Dimension	MOQ
1m	20pcs	1030*190*83mm	100PCS
1.5m	20pcs	1530*190*83mm	100PCS
2m	20pcs	2030*190*83mm	100PCS

- Four joining accessories are available to give I,L,T and X installations,as listed below

Model	QTY/CTN	CTN Dimension	MOQ
U	100pcs	1375*195*225mm	100PCS
LJ	50pcs	1370*1235*140mm	100PCS
TJ	50pcs	1375*195*225mm	100PCS
XJ	25pcs	1360*220*175mm	100PCS

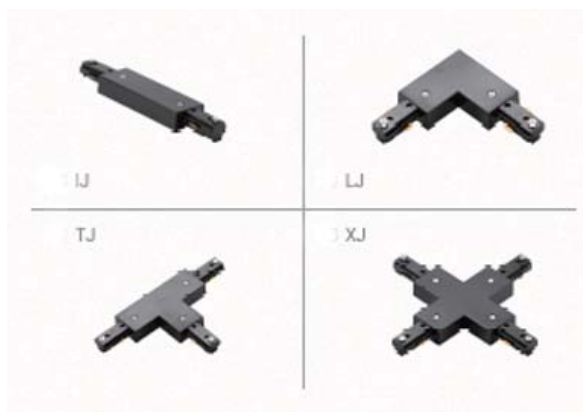

WATERPROOF BATTEN LIGHT

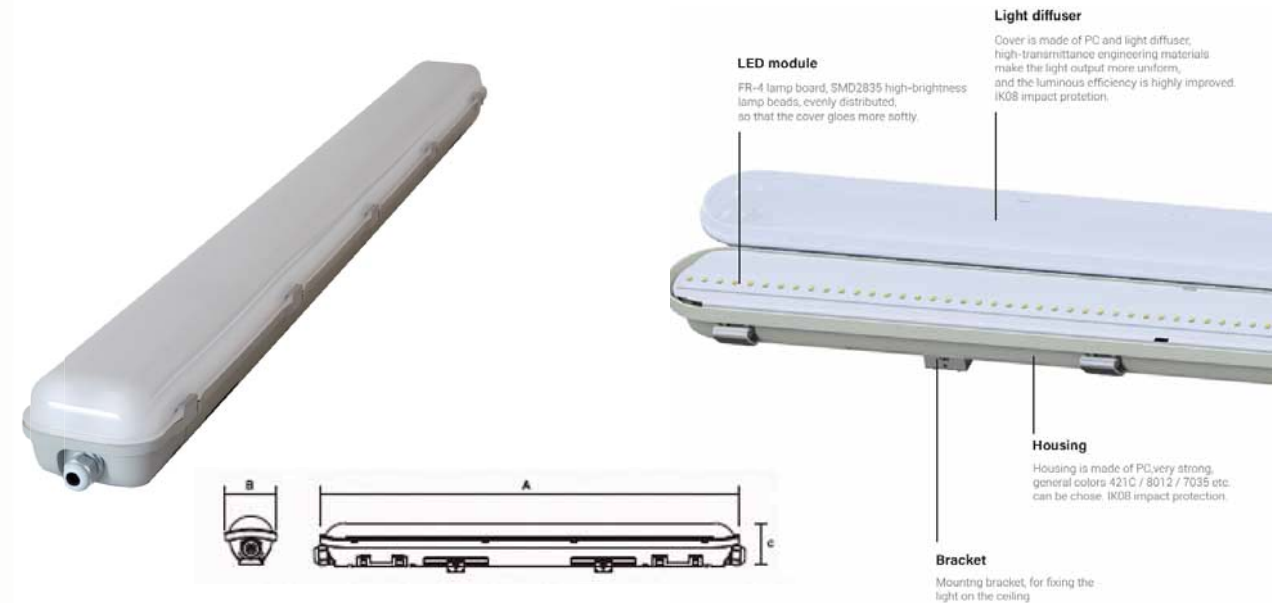

APPLICATIONS

- General
- Factories
- Carparks
- Warehouse

TECHNICAL DETAILS

- SMD LEDs

CONSTRUCTION

- PC housing and opal PC diffuser
- LED driver included
- Internally mounted sealed clips
- Sliding clips mounting

OPTIONS

- Emergency 3hrs(2.5w)

OPTIONAL ADDITIONS

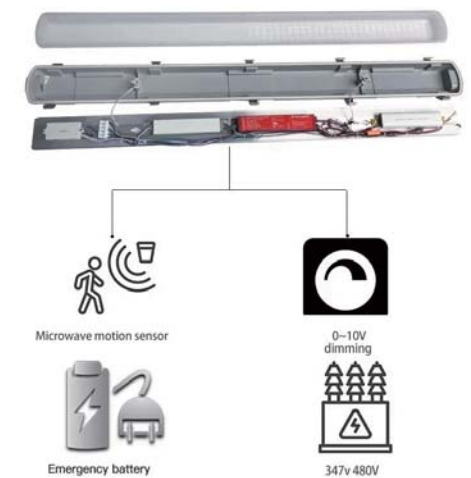

Item No	Power	Voltage	Luminous Flux	Beam angle	CRI	CCT	Lifespan	PF	Size(mm)
ZL-B2FS-17W	17W	220-240V	2000lm	115	80	4000K	30,000hrs	0.9	600*80*72
ZL-B4FS-22W	22W	220-240V	2600lm	115	80	4000K	30,000hrs	0.9	1200*80*72
ZL-B2FD-22W	22W	220-240V	2600lm	115	80	4000K	30,000hrs	0.9	600*115*72
ZL-B5FS-36W	36W	220-240V	4320lm	115	80	4000K	30,000hrs	0.9	1500*80*72
ZL-B4FD-40W	40W	220-240V	4800lm	115	80	4000K	30,000hrs	0.9	1200*115*72
ZL-B5FD-57W	57W	220-240V	6840lm	115	80	4000K	30,000hrs	0.9	1500*80*72

(S)=Single LED Strip (D)=Double LED Strip